

SECTION C

CLASSIC MODEL - ON SLAB - ABUTMENT UNDER HANDRAIL

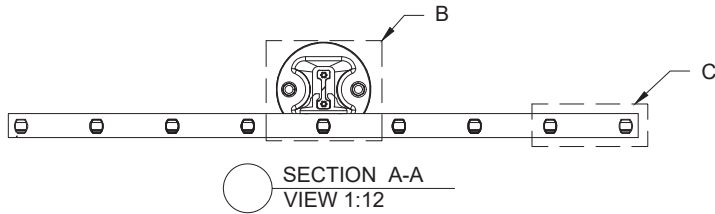

\* VARIABLE SPACING BETWEEN THE BARS,  
PLEASE VALIDATE WITH RAMP-ART

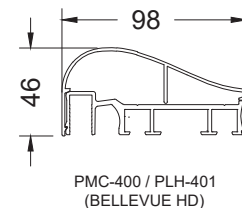
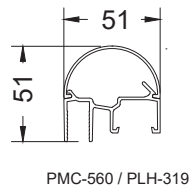
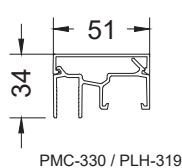
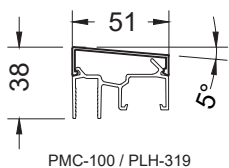
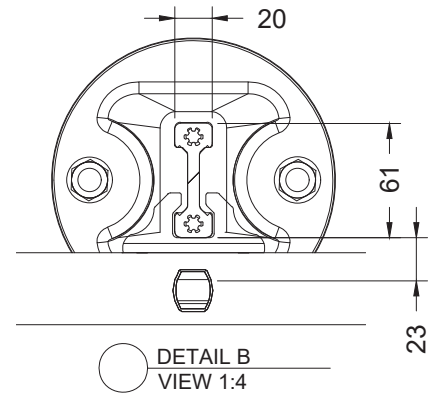
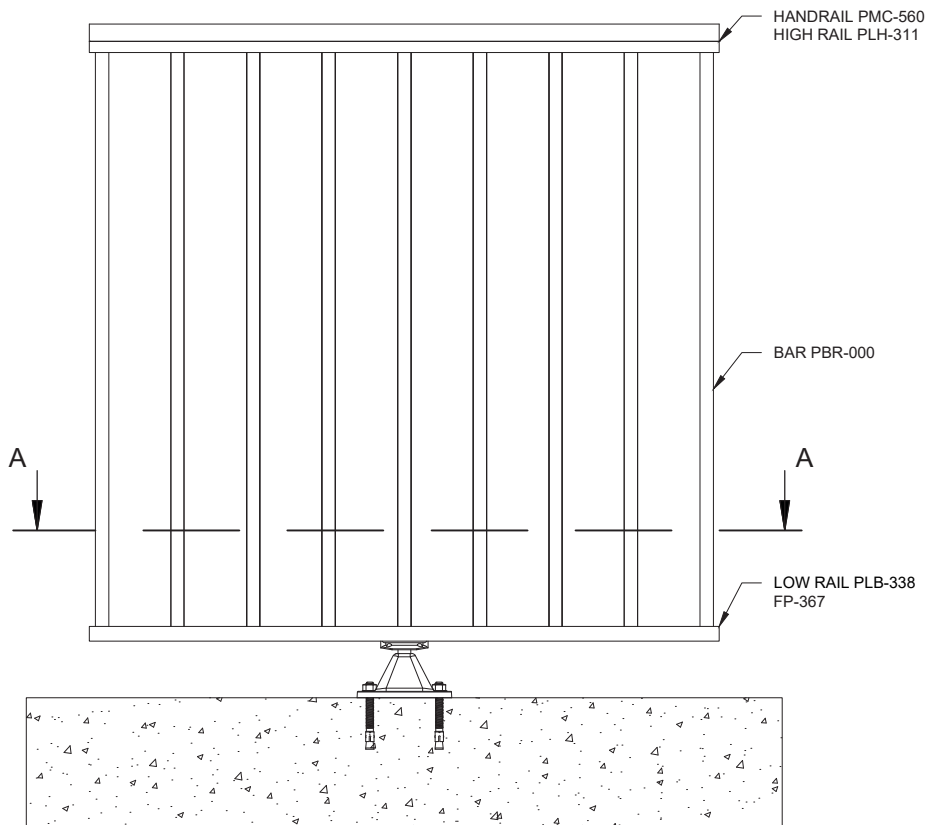
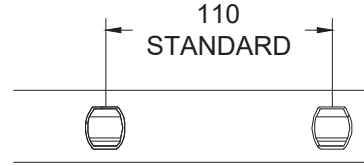

## CHOICE OF HANDRAILS

### CLASSIC MODEL - ON SLAB - ABUTMENT UNDER HANDRAIL

SECTION C

Scale : 1:12